

DESCRIPTION: Rg5 body gate valve, Rg5 wedge. Rising stem, screwed bonnet. Flat face flanged.

APPLICATION: Start/stop flow with minimized pressure drop for air/gases, sea water, water, oils etc.

STANDARD & DESIGN:

Design Code: JIS F7367
 Inspection Std.: JIS F7400
 End Std.: JIS B2240
 Face to Face Std.: -
 Flanges drilled: JIS 5K(DN15-DN40)
 Pressure rating: JIS 5K(DN15-DN40)

VARIATIONS: Other dimensions and materials on request.

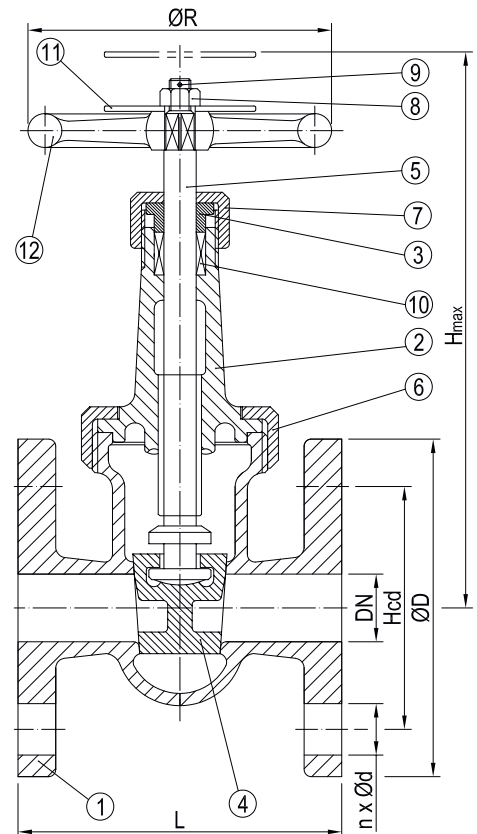
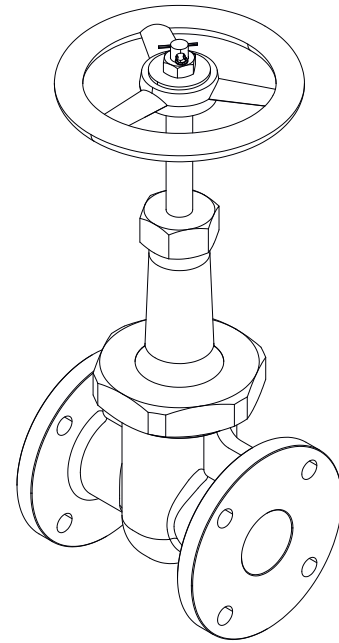

No	Part	Material	Code
1	Body	Bronze	BC6
2	Bonnet	Bronze	BC6
3	Gland	Brass	C3771 BE
4	Wedge	Bronze	BC6
5	Stem	Brass	C3771 BE
6	Union Nut	Bronze	BC6
7	Gland Nut	Brass	C3771 BE
8	Hexagonal Nut	Stainless Steel	SUS 304
9	Split Pin	Brass	C2600 W
10	Packing	Graphite	-
11	Name Plate	Aluminium	Al
12	Handwheel	Cast Iron	FC 200

DN	n x ød	Hcd	øD	L	H _{max}	øR	Kg
15	4x12	60	80	90	175	80	2.3
20	4x12	65	85	100	200	80	3.0
25	4x12	75	95	110	220	100	4.1
32	4x15	90	115	130	250	100	5.8
40	4x15	95	120	140	290	125	7.8